

U9 9 9
 SILICON SHEET
 BUSHING

FS : FILTER SHIELD
 FES : FRONT END SHIELD
 BR : BARRIER
 HS : HEAT SINK
 3x6 B : BIND HD SCREW
 3x8 C : CEMS SCREW

EXPLODED VIEW

MODEL
 933/934 PPS/CB
 1986-9

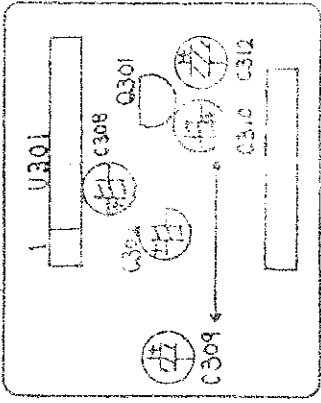

(A103) PTB172
Component Side View

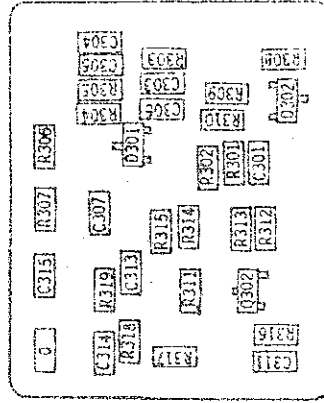

Chip Parts Location

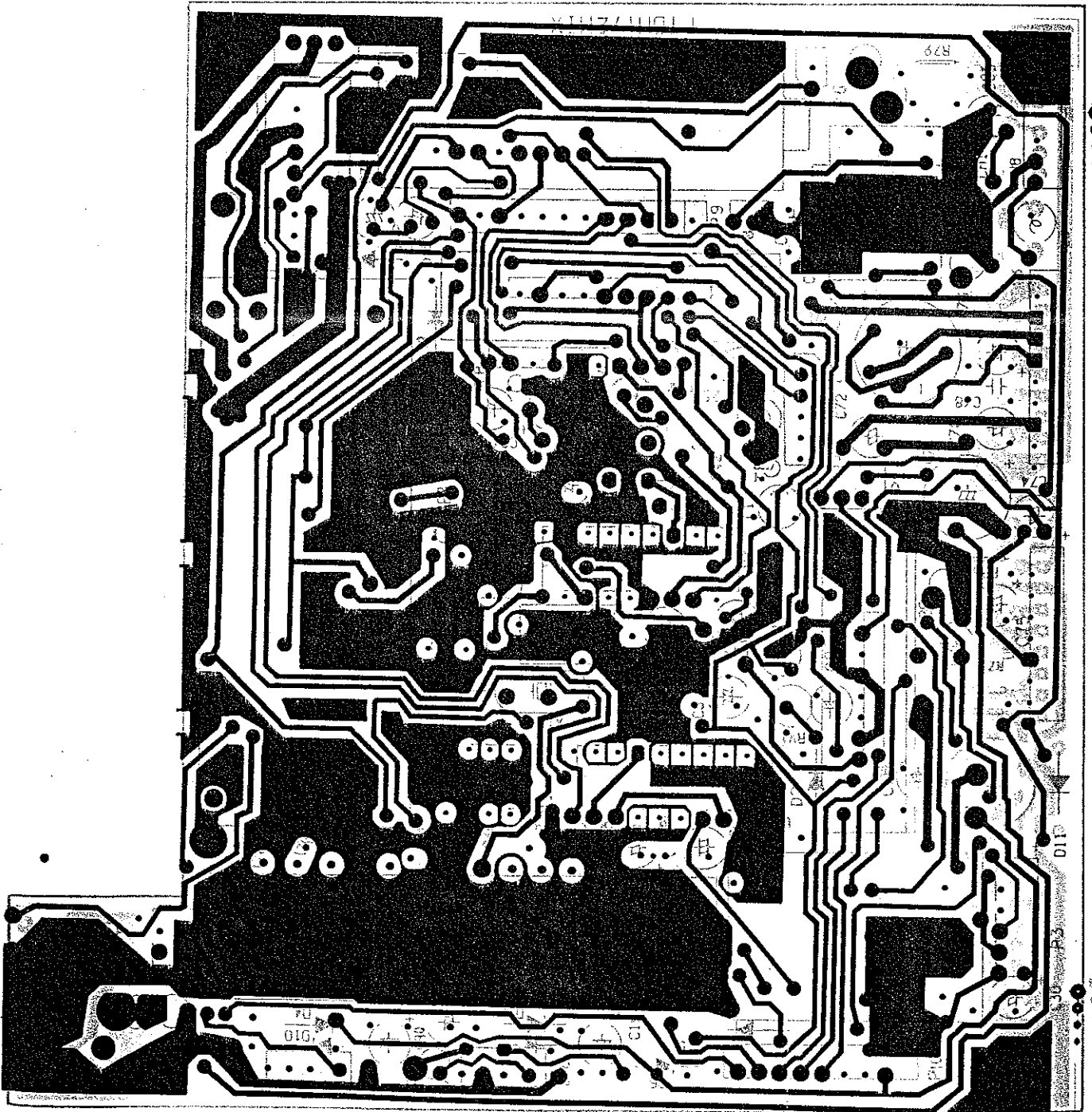

(A101) PTB172 Component Schematic Side

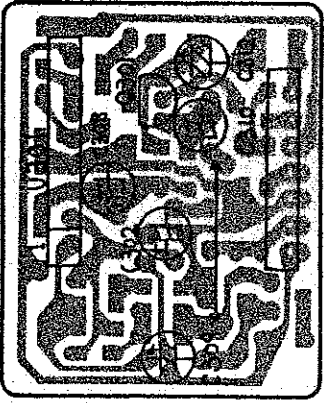

(APO3) APT221/3
Component Side View

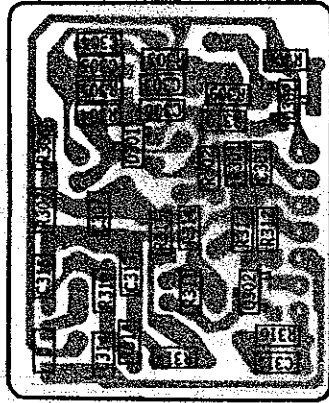

Chip Parts Location

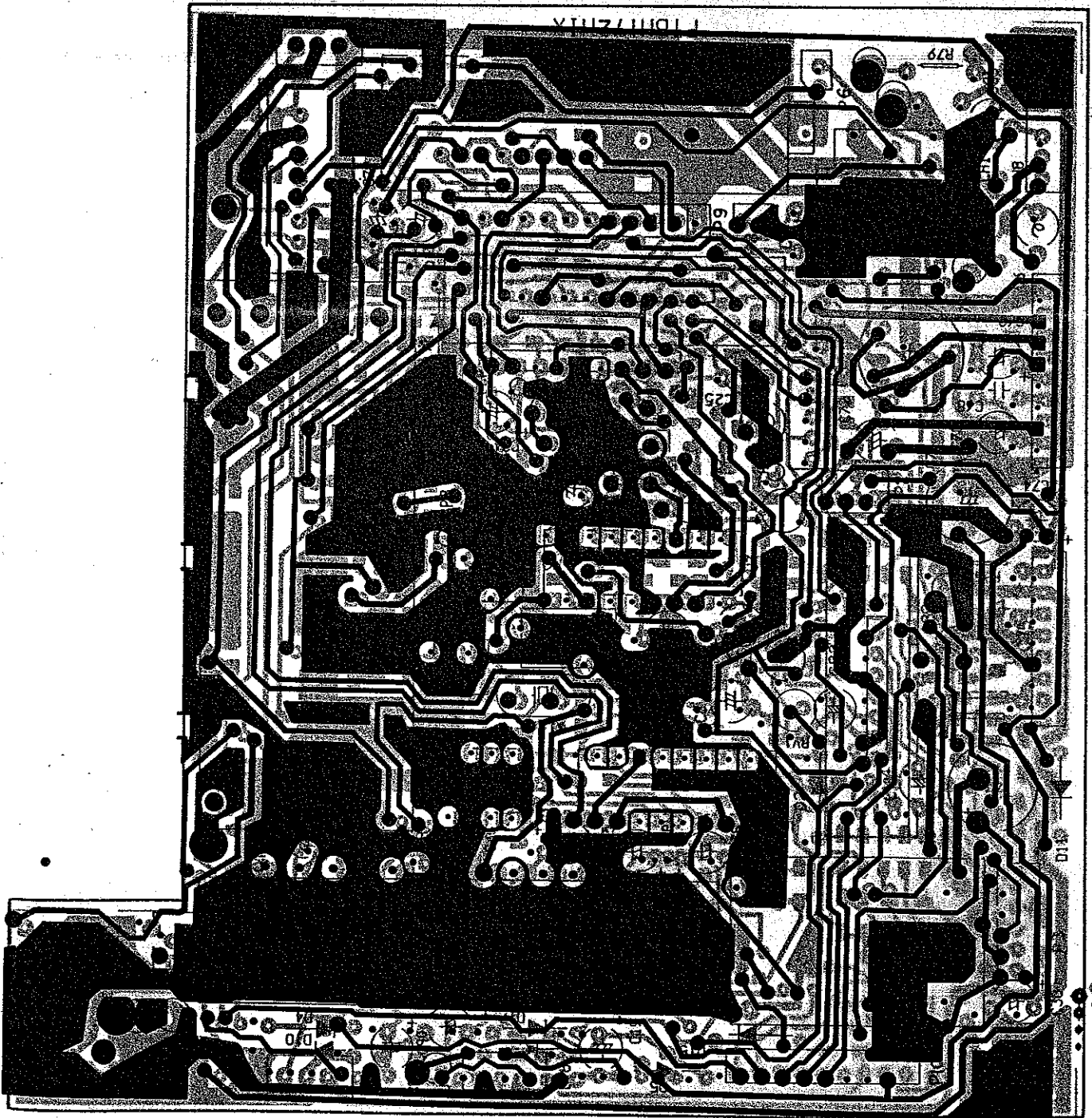

(AP01) PTBM 172 Component Schematic Side

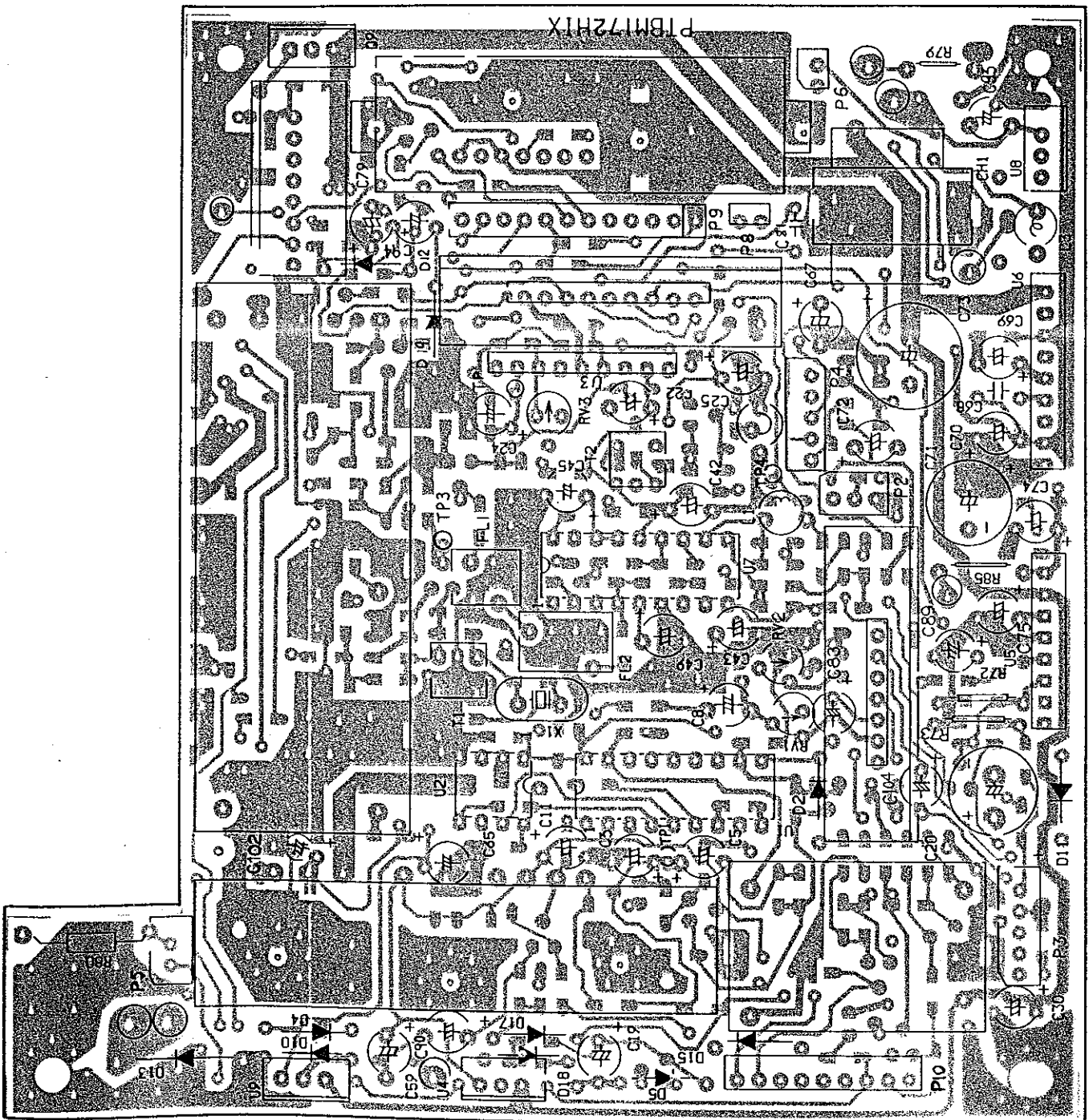

PTBM172H1X

(AP01) PTBM 172 Component Side View

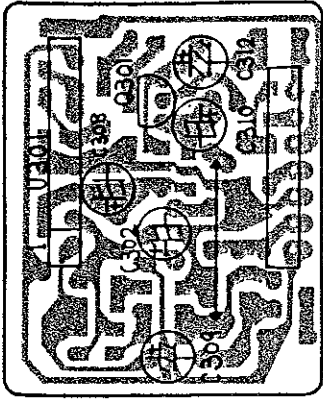

(AP03) APTZZ113
Component Side View

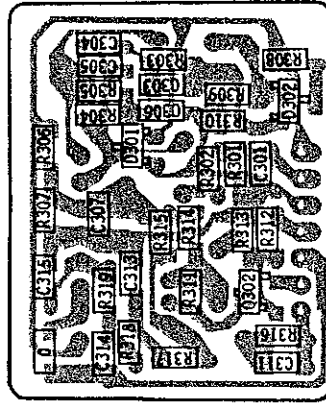

Chip Parts Location

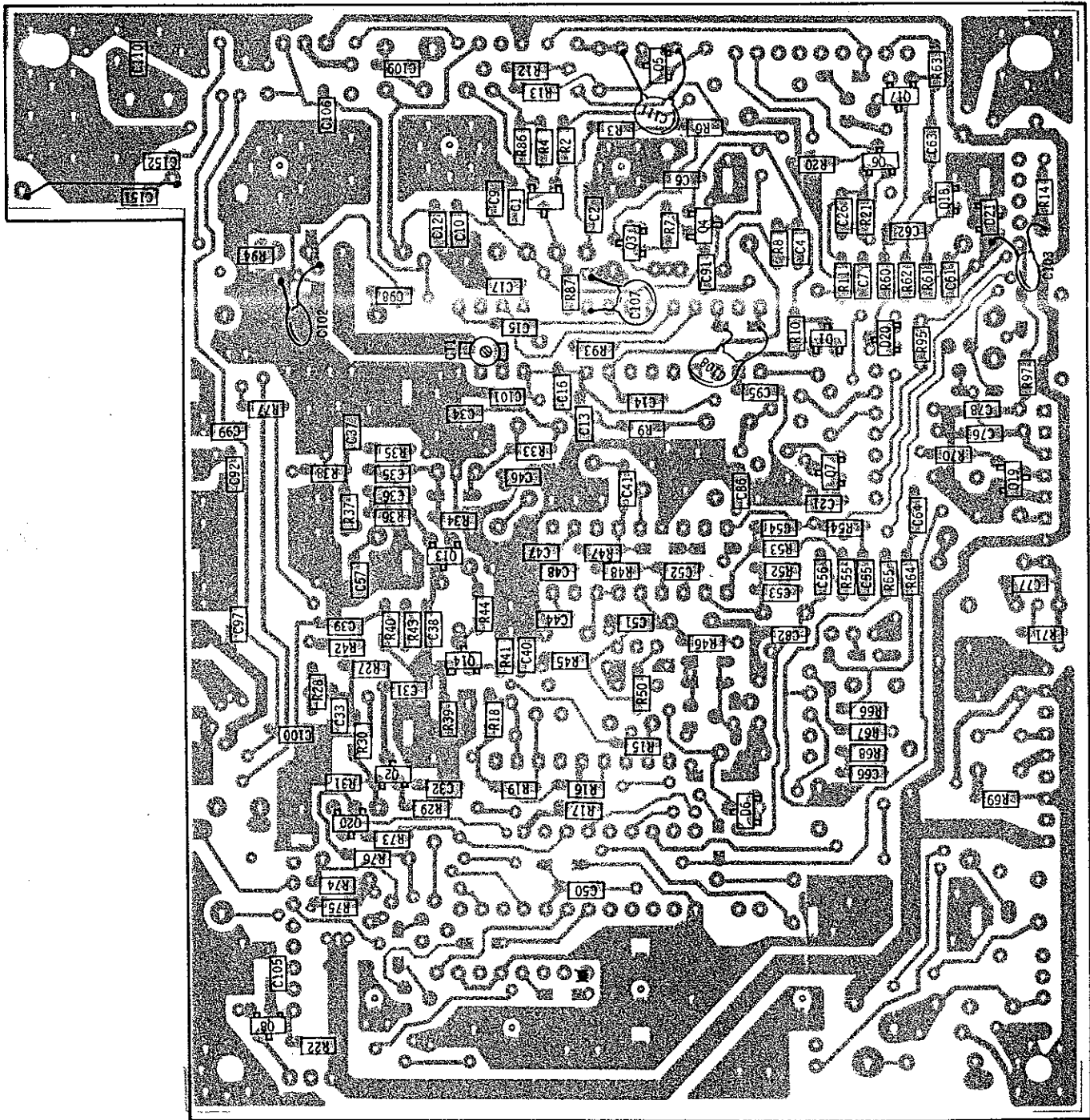

(AP01) APTBM172 Chip parts location

Component Side View

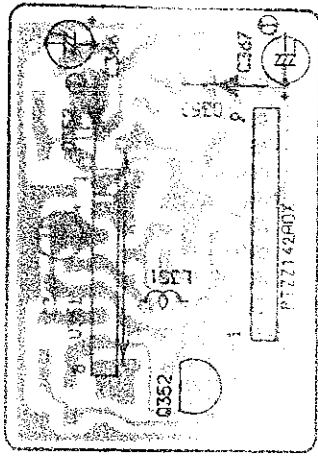

(A04)

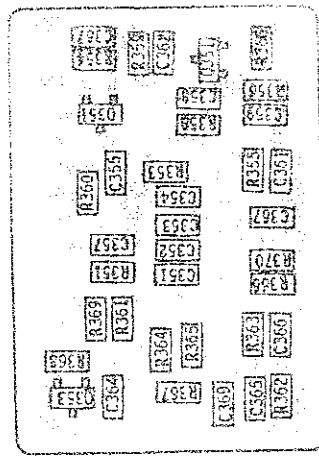

Chip Parts Location

Component Side
Component Side

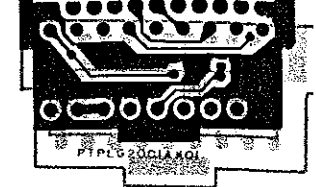

(A13)
APTPL9200/

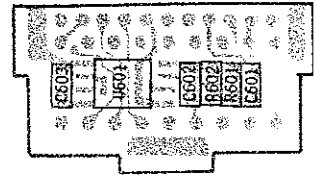

Chip Parts Location

Component Side

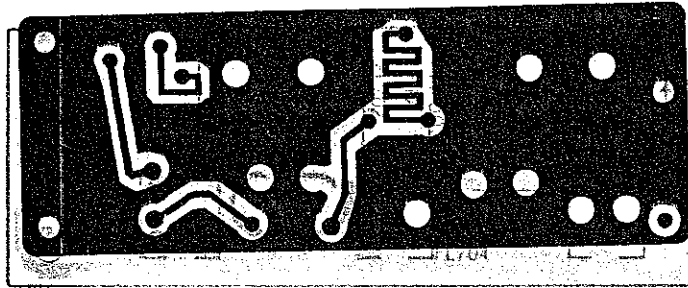

Component Side

(A07)
APTTF002

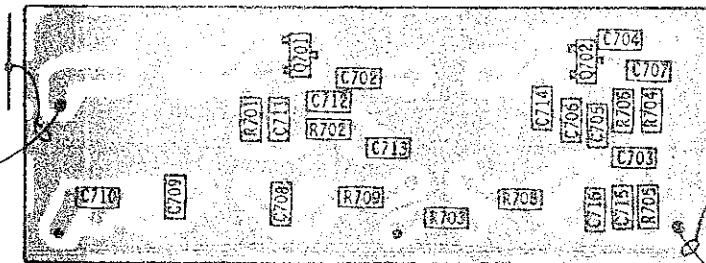

Chip Parts Location

Component Side

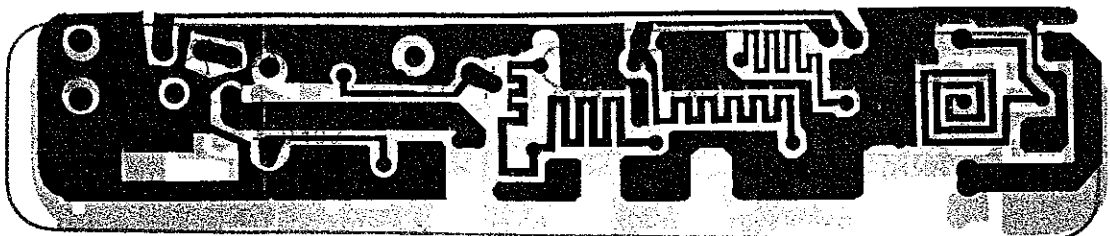

Component Side View

(A11)
APTTX022

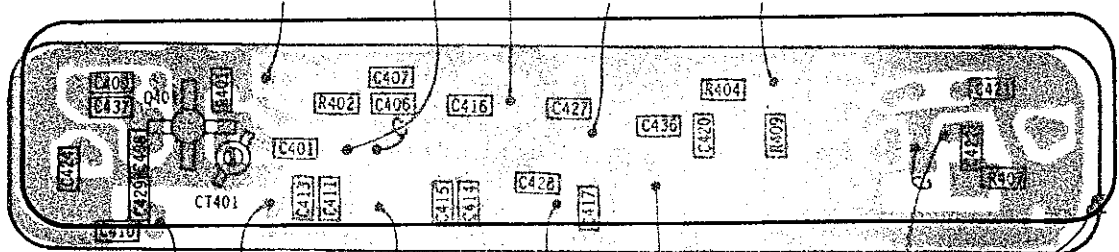

Chip Parts Location

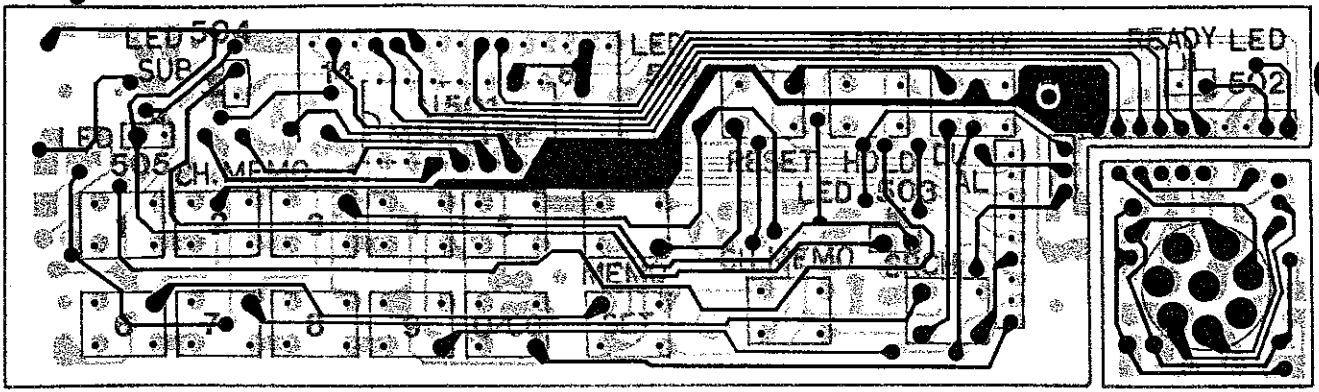

Component side

Component Side View

(AP05)

APT8W211

APT88150
(AP12)

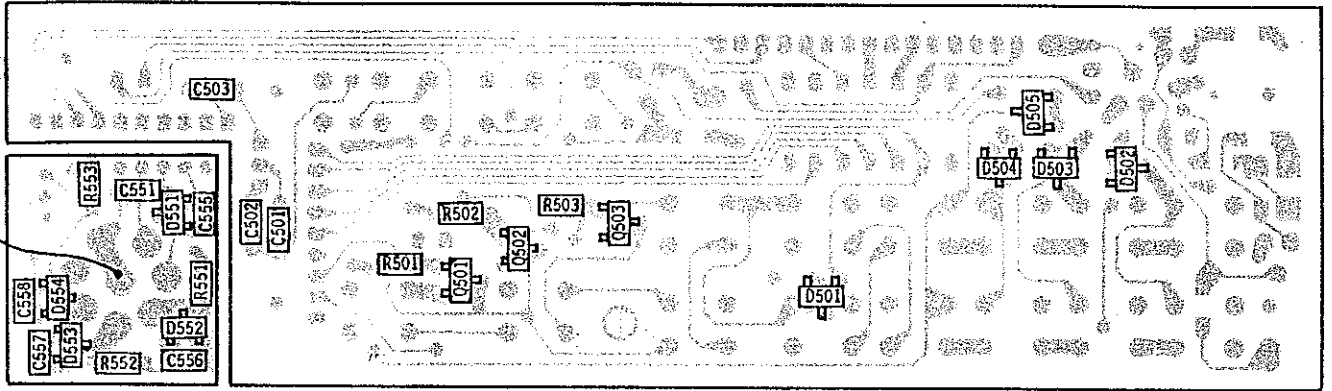

APT88150

Chip Parts Location

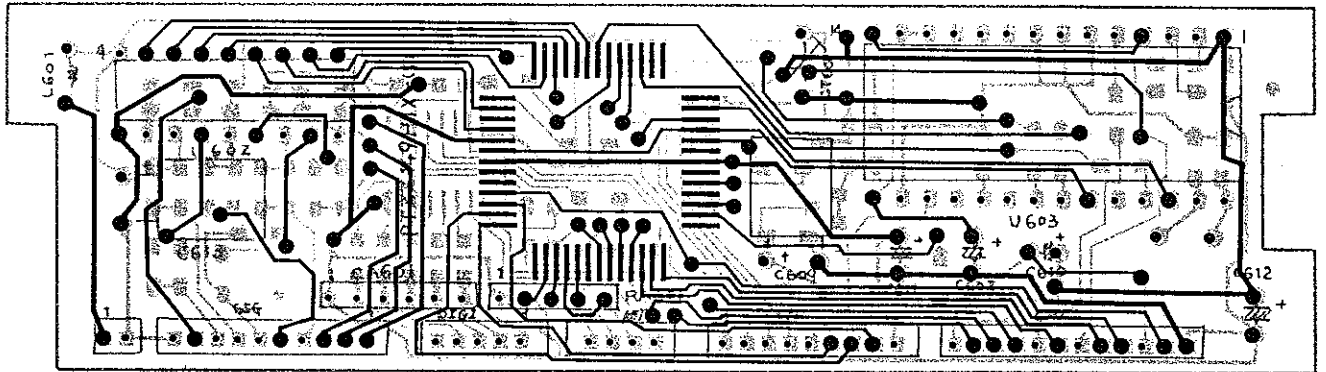

Component side

Component Side View

(AP06)

APT88149

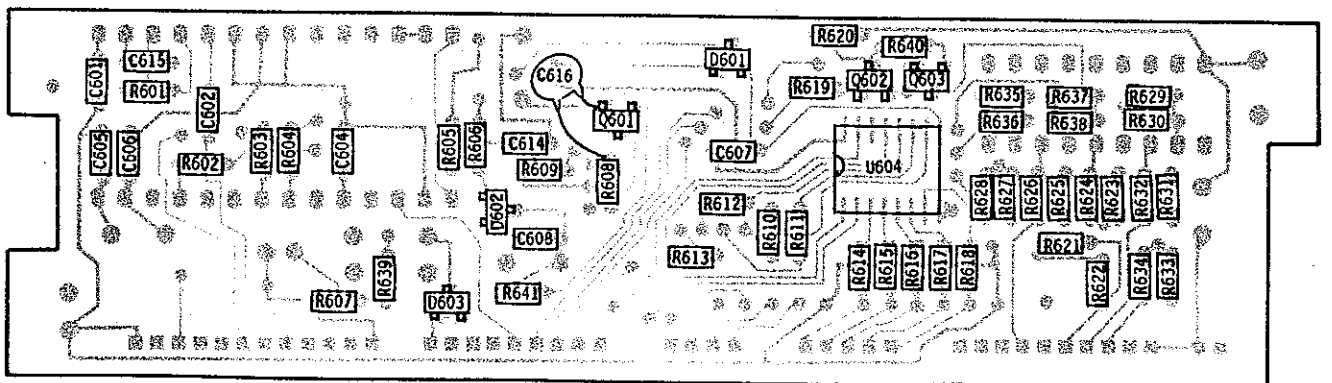

Chip Parts Location

Component
Side
View

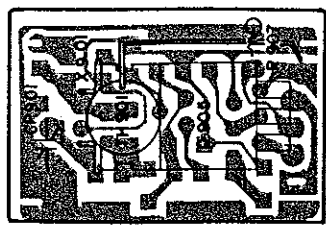

Chip Parts
Location

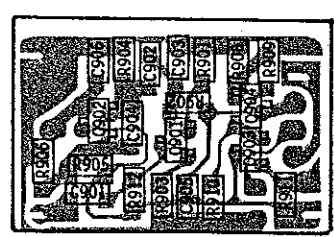
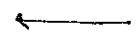

(AP08) APT08013

Component
Side
View

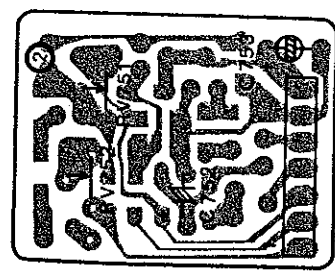

Chip Parts
Location

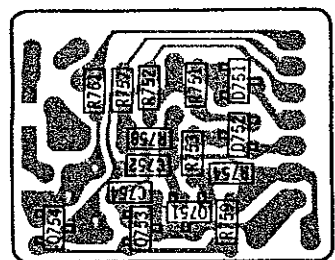
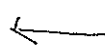

(AP10) APT22115

* (AP02) and (AP09) are omitted.

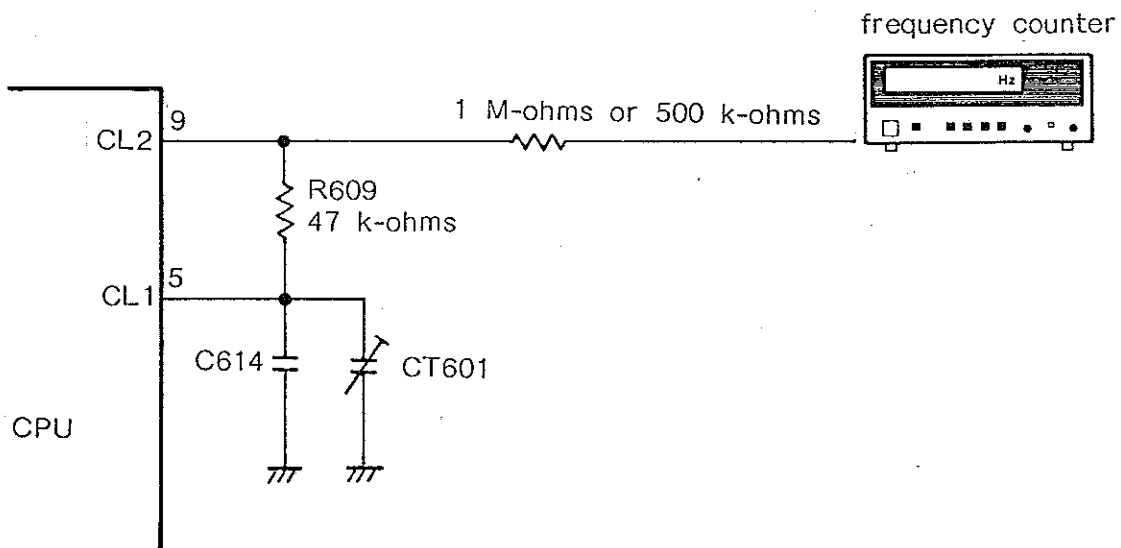
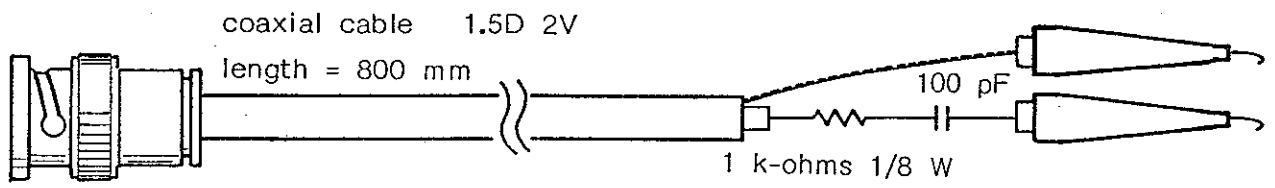

Stabo. 933/934
10.28.86

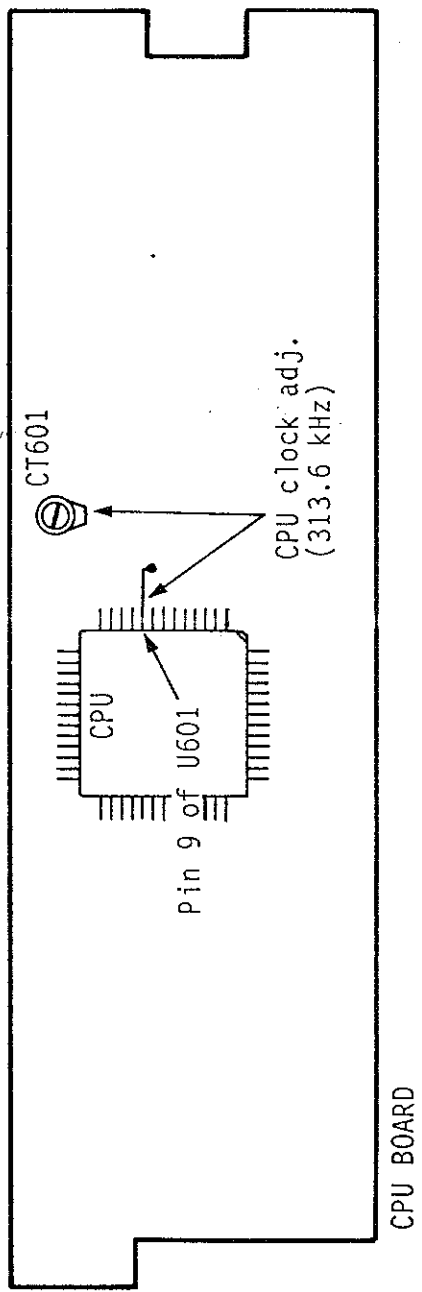

933/93

7506/806

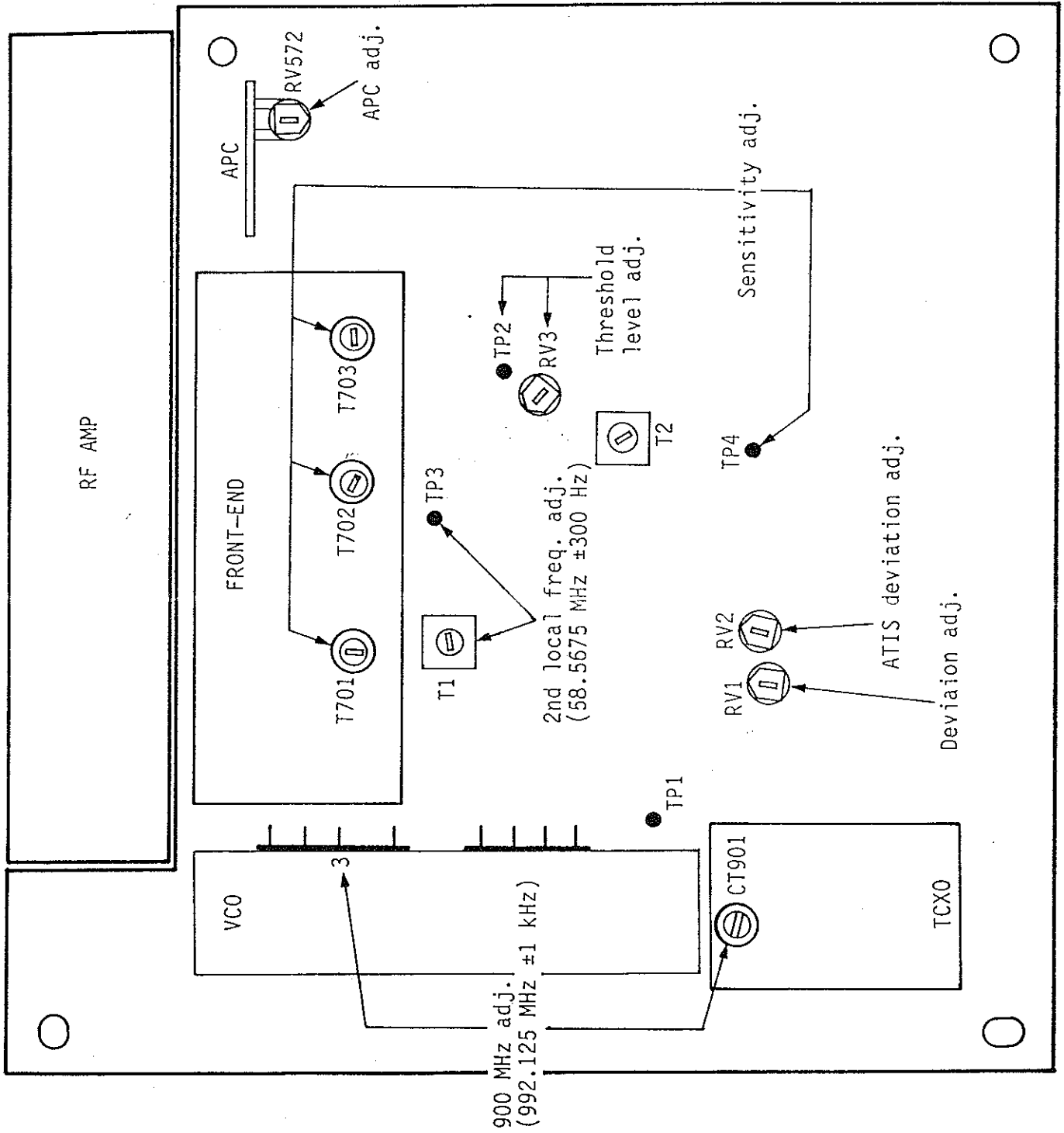

BOTTOM VIEW

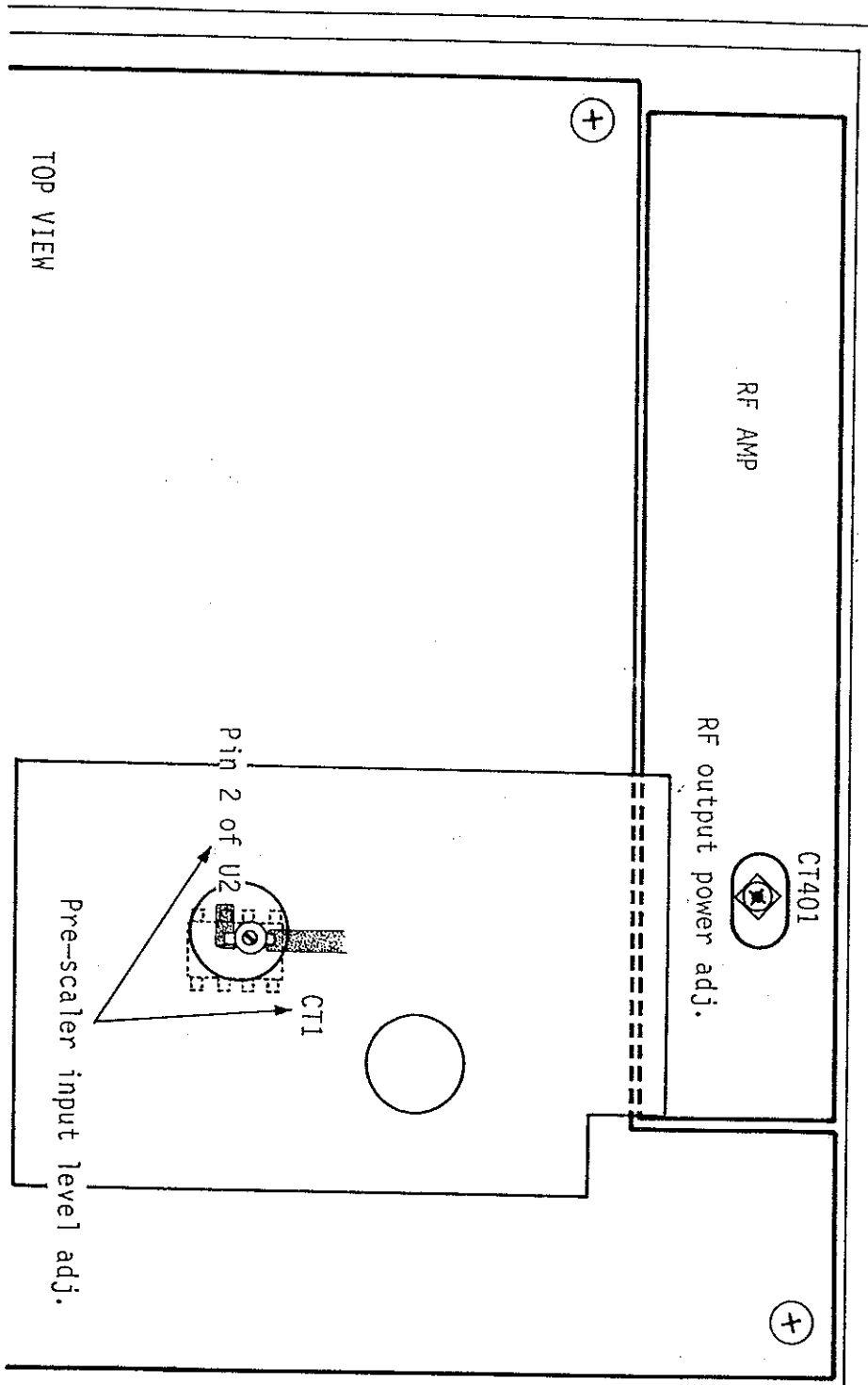

TOP VIEW

RF AMP

RF output power adj.

CT401

CT1

Pre-scaler input level adj.

Pin 2 of U2

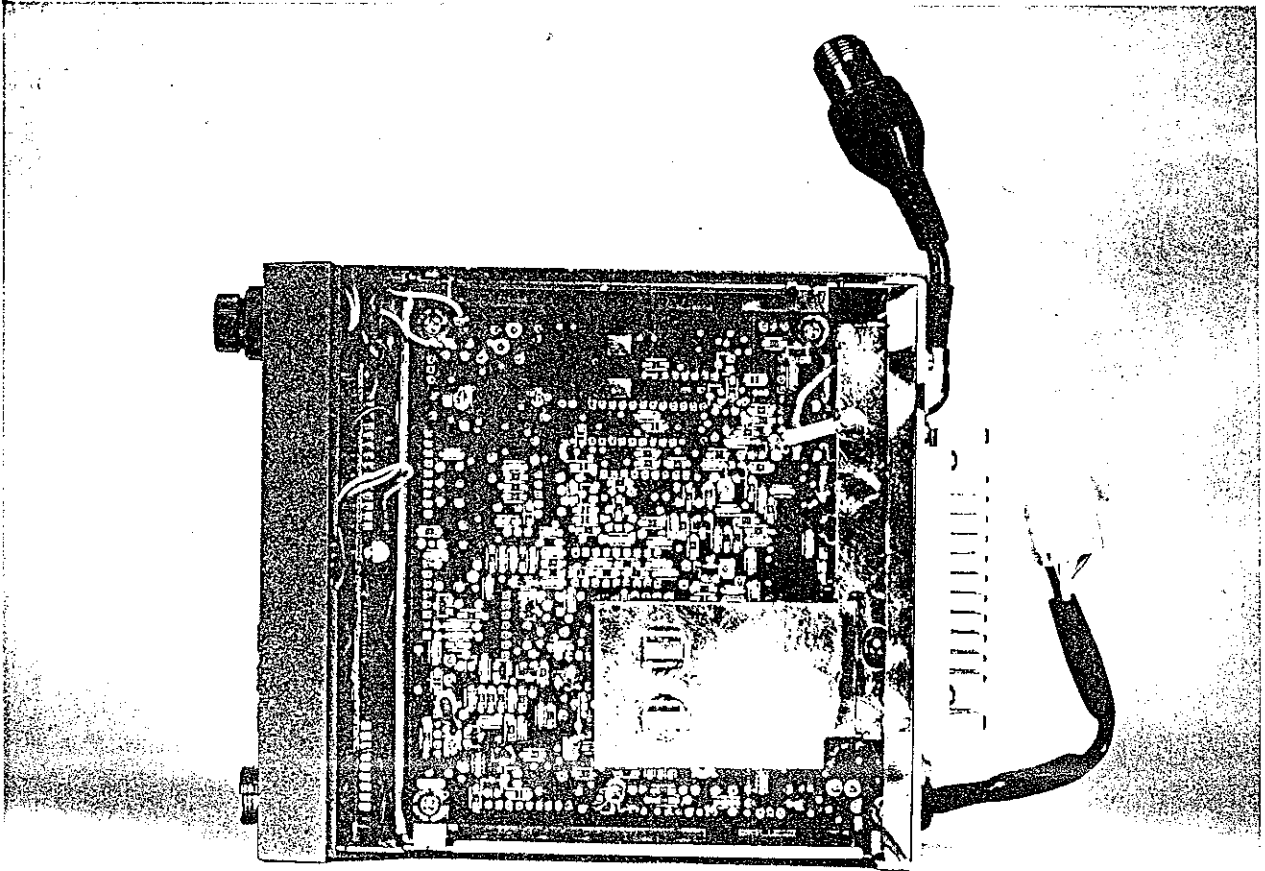

PTT 10901

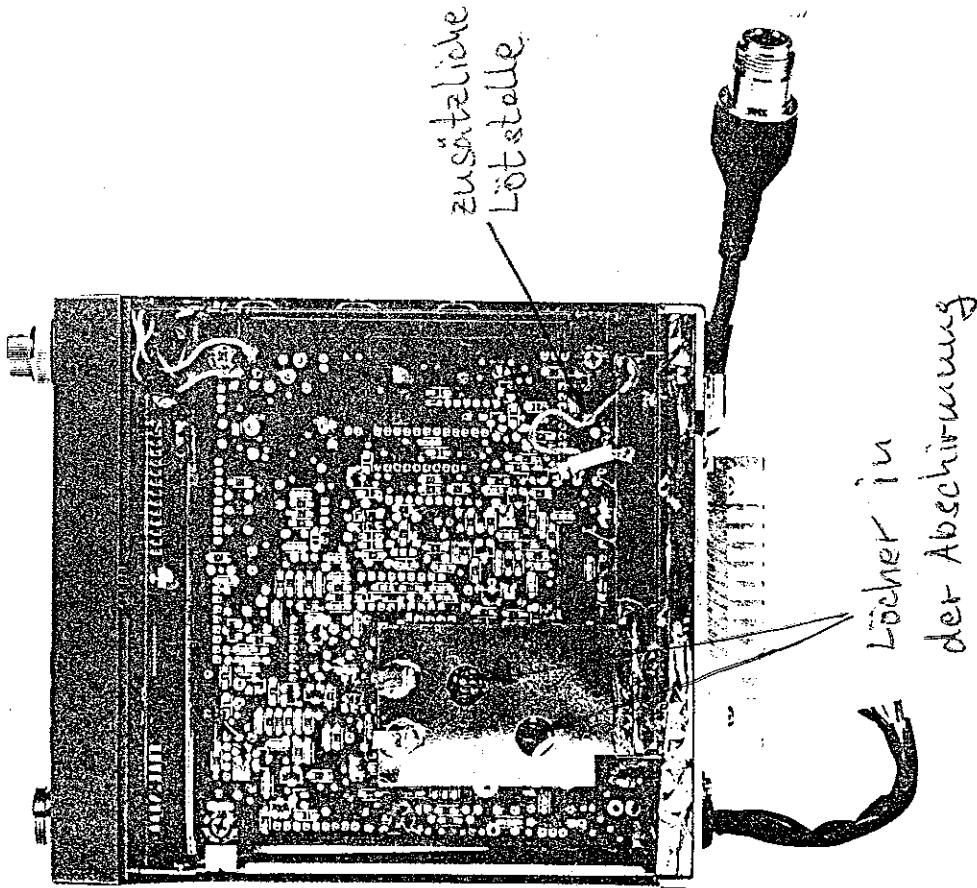

zusätzliche
Lötstelle

Löcher in
der Abschirmung